

N $\frac{1}{2}$ L
 220 - 240V

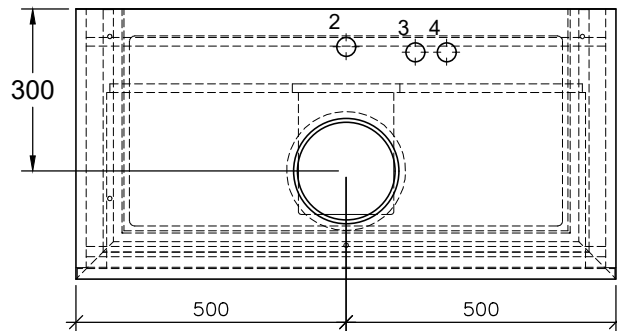

	1	2	3	4	H2	A1
5144 00 / 01	X		X	X	1010	590
5148 00 / 01	X	X	X	X	1010	590
5149 00 / 01	X	X	X	X	1010	590
5149 10 / 11	X				1010	590
5151 00 / 01	X	X	X	X	1010	590
5151 10 / 11	X			X	1010	590
5154 00 / 01	X	X			1010	590
4110 45	X			X	1090	600
4110 60	X	X			1090	600
4110 80	X				1090	600
4132 60 / 61	X		X		1070	630
4125 40 / 41	X		X	X	1070	630
4126 60 / 61	X			X	1070	630
4127 60 / 61	X				1070	630
4179 43	X		X	X	1070	590
4198 61	X			X	1070	590
4172 58	X	X			1070	590
4178 41	X				1070	590
4A1840	X		X	X	1090	590
4A2138	X	X		X	1090	590
4A1956	X	X	X	X	1090	590
4A2056	X	X	X	X	1090	590

Legato
 B57200XX / B572L0XX

V01 / 28.08.2019

1:12